

millboard

Live. Life. Outside.



Installation Guide for
Millboard Envello Cladding

EN - UK

Shadow Line - Horizontal



Contents page

Easily find your way around the Millboard Envello®
Cladding installation guide for Shadow Line - Horizontal

About Millboard	4-5
Product Suitability	6
Intended uses & limitations	6
Pre-installation	7-9
Storage & handling	7
Tools & PPE required	8
Cutting	9
Fire performance	9
Materials	10-15
Colour characteristics	10
Material Calculator	11
Cladding boards & accessories	12-15
Preparation	16-19
Ventilation	17
Cladding support	18-19
Installation	20-23
Corners of buildings	20-21
Joining corner trims	21
Details around windows & doors	22-23
Starter trims	24
Fixings	24
Joining boards	25
Installation abutting render	26
Aftercare	27

About Millboard cladding

A closer look

Millboard cladding uses a unique material, unrivalled across the globe. Take a closer look at the construction and performance of this stunning yet functional cladding.



Tough

The unique Lastane® layer is more resistant to scratches and stains and is designed to better withstand demanding outdoor environments.

Enduring

The dual-tone Lastane® surface is hand tinted using pigments designed to improve resistance to sun damage and fading.

Beautiful

Each length is hand moulded using specially selected timber masters for an unrivalled organic wood-grain appearance in a composite material.

Safer

Millboard cladding is wood-free and non-porous which, in comparison to timber, means good resistance to algae growth and a splinter-free surface.

Durable

Millboard will not split, rot or harbour insects like timber does

Lighter

Our unique closed 'cellular' internal structure reduces weight while maintaining strength.

Stronger

The structural core is a blend of natural minerals bonded in a polymer resin with renewable biopolymers and fibre reinforcement for added strength and durability.



The Shadow Line board has been designed to perfectly replicate smooth timber with a flat grained finish, giving a clean authentic look. The increased width of the Shadow Line board compared to standard timber boards means that there is larger grain detail. This gives an enhanced visual impact, without the risk of the board twisting or warping over time.

The Shadow Line board has been profiled with oblique angles to prevent water collecting between two profiles, as well as helping rain water wash over the face of the cladding. The indent created between boards gives visual definition to the individual grain patterns.



Ultra-realistic wood-look
Skilfully moulded by hand & authentically coloured - replicating timber in the most realistic way.



Impact resistant
A durable coating & elastomeric surface ensures increased resilience against hail & natural weathering.



Resistant to moisture ingress
Due to Envello's non-porous composition no sealing is required, unlike other available products.

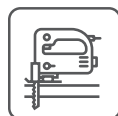

Easy installation
No specialist tools required, Envello can be cut & installed in the same way as traditional timber.



UV & Weathering stability
UV stabilised for better performance & fade resistance over time.



Does not warp or rot
Envello is solid - not hollow, making it strong, meaning it won't rot or warp like timber.

Crafted to be perfectly imperfect

Each length of Millboard cladding is the result of a long process of craftsmanship and attention to visual detail. Just like the specially selected Oak timbers used to create the unique moulds, the fine details and natural imperfections in the original material has to be recreated in the super durable millboard product.

From the initial laying of the Lastane surface, right through to the pouring of the fibre-reinforced resin mineral, we focus on achieving the quality of finish, reflecting the true random and natural characteristics of the original timber. Our mission is to accurately reproduce the original whilst adding all the benefits of our unique board technology, this is why many of our processes are carried out manually. For example, each piece is hand coloured to establish the authentic wood finish our boards are renowned for.

Product Suitability

Intended Use

Envello Cladding has been designed for beauty, longevity and ease of installation on residential and low-rise buildings. However, to ensure the best installation and long-term performance, we recommend that a professional tradesperson carries out the installation.

Millboard recommend that all cladding designs are approved by a licensed architect or engineer prior to installation. It is the property owner's responsibility to make sure that your plans meet any relevant local building regulations before the installation begins. Envello Cladding must be supported by a suitable substructure that is in accordance with building regulations.

Envello Cladding is a rainscreen cladding system which can be described as 'A wall comprising an outer skin of cladding boards and an airtight insulated backing wall separated by a ventilated cavity. Some water may penetrate into the cavity but the rainscreen cladding is intended to provide protection from direct rain'. Therefore, a well ventilated, free draining cavity should always be included in the detailed design.

It is not recommended to use Envello Cladding in structural applications, as it would need to be fixed to a structural frame of battens.

Limitations

This installation guide is not exhaustive as the responsibility for design lies with the specifier or responsible party for the project, to ensure the final design meets the requirements of the intended application and Building regulations.

For designs outside the scope of this installation guide, specific design must be undertaken by an architect or designer.

If in doubt, we would strongly recommend contacting Millboard pre-design stage to arrive at a suitable, robust, efficient solution and to avoid disappointment.

It is the responsibility of designers, installers, and owners to ensure that the information in this manual is current, by checking with Millboard or referring to our website. As new technology is introduced or industry standards are altered, Millboard reserves the right to alter existing specifications and remove products without notice. Visit our website on: www.millboard.co.uk

The use of this manual: does not guarantee acceptance or accreditation of a design, material or building solution by any entity authorised to do so under law; does not mean that a design, material or building solution complies with the building regulation; or does not absolve the user from complying with any local, or Government legal requirements.

Pre-Installation

Storage and Handling

Millboard Envello Cladding boards should always be stored on a flat surface or level bearers a maximum of 400mm apart and stacked face-to-face, not back-to-face. Both external and internal corner profiles should be fully supported along their length.

When loading and unloading by hand, make sure that both ends are lifted on the edge to avoid permanent deformation and/or damage to the boards.

They should only be lifted off the stack, and not dragged as this could cause abrasion or marking on the surface.

Wear gloves and long sleeves when handling the boards and take care when lifting them. We recommend that two people carry the boards, they should be carried on their side for increased rigidity.

We advise that the cladding planks are stored on site at least 72 hours before installation, to allow the boards to climatize. Only move the pallet if the boards are safely strapped to it.

Millboard cannot be held responsible for damage caused by improper storage and handling of the product.

Tolerances:

There will always be a slight variance in the board's dimensions due to the fact that we mould from natural oak, and due to the pressure of the moulding process. Despite this, we calibrate the boards to maintain as consistent a profile as possible.

The manufacturing tolerances are: Width: ± 2 mm. Length: ± 5 mm. Thickness: ± 2 mm.

When working with the boards, a level may be required to help keep the boards running level or upright.

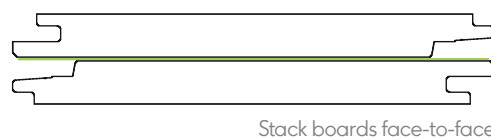

Stack boards face-to-face

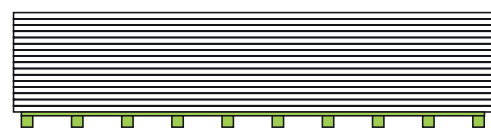

Ensure boards are on a flat surface or bearers max. 400mm apart

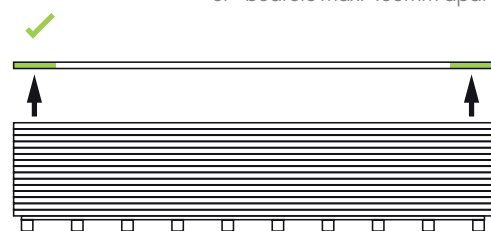

Lift boards on the edges using 2 people to lift at a time

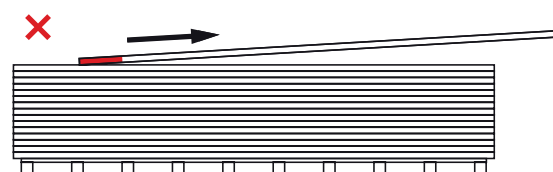

Do not drag the boards off the stack



Ensure boards are secured to the pallet before transporting

Tools & PPE required

The tools and PPE you will need to install the Millboard Envello Cladding product.

If you are unsure on how to use any tools, please consult the tool's manufacturer's user manual.



Mitre saw/jigsaw/handsaw
Millboard Envello Cladding products can be cut with standard wood cutting tools (i.e. mitre saw, jigsaw, handsaw). We recommend using a carbon-tipped saw blade. An aluminium cutting blade should be used for the metal trims.



Personal Protective Equipment
When handling Millboard products, it is advised to wear long sleeves and gloves. When cutting products it is advised to wear a FFP3 dustmask, ear defenders and safety glasses.



Tool set
Standard carpentry tools will be needed to complete the installation, including: tape measure, a pencil, set square, planer, stanley knife, surform and a drill bit set.



Power drill and driver
Standard power drill drivers can be used to fix the cladding products. Impact drivers are not recommended to be used when using the Durafix fixings.



Spirit level
A spirit level is used to ensure that the battens are upright and the starter trims are level.



Laser level/line
If available, a laser level can be used to ensure the starter trims are installed level.

Cutting

Envello products can be cut with standard wood cutting tools (i.e. mitre saw, jigsaw, handsaw), we recommend a carbon-tipped saw blade. An aluminium cutting blade should be used for the metal trims.

When cutting the boards, wear an FFP3 dust mask, safety glasses, long sleeves and protective gloves.

A dust bag or vacuum must be used on mitre saws.

Make sure that the boards are adequately supported when cutting. Boards can be cut face-up or face-down.

When the board is cut, Touch-up Coating should be used if the cut will be visible and exposed to UV.

Dispose of board off-cuts by disposing as general waste or sending to a municipal incinerator for energy replenishment, don't burn them at home.

Tip:

If there is a breeze/wind when cutting the boards, locate the saw up wind so that excess dust is blown away from the operator & project.

Fire Performance

Millboard Envello cladding boards are crafted with fire retardants in the board composition, however they are not fire rated and carry no 'reaction to fire' certificate.

The responsibility for the cladding's suitability in the required location is to be determined by a certified building professional (building control, building insurance, fire officer, etc).

Millboard will not be held responsible for incorrect specification, application, or product installation in areas not in accordance with government guidance, in the UK or abroad.

Current guidance should be gained from the government website relating to the geographical project location, England's building regulation Approved Document B can be found on - <https://www.gov.uk/government/publications/fire-safety-approved-document-b>



Materials

Colour Characteristics

We go to extraordinary lengths to recreate the look of natural products and therefore intentionally add secondary toning colours. This painstaking process means that there may be variance within the same board or between boards.

Millboard Envello Cladding has been designed to replicate the natural variances of timber and is manufactured to have tonal variance in the colour.

Buying all the Millboard you need at the same time should help to ensure that the colour is consistent. If you do have multiple batches then it is best to mix the boards, to create an effective, subtle blend.

Antique Oak boasts more tonal variation per individual board than any of the other colours in the Millboard range.

As with all products exposed to the Sunlight (UV), Millboard will naturally weather and tone down over time. Loss of gloss is perfectly normal and will not affect the performance of the products.

Millboard takes great care ensuring the performance of its products maintain the timber effect we seek to portray, and we believe at every stage of its life Millboard truly reflects this more than any other timber alternative product, due to being moulded from real timber and the hand coloured process.

On delivery if you find the colour unacceptable or believe them to be defective in any way, please contact us. If there are any foreseen issues with the boards, this should be highlighted with Millboard before installing.



Smoked Oak



Antique Oak



Golden Oak



Burnt Cedar

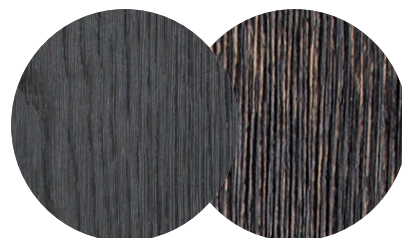

↑ Colour tone may vary from batch to batch.
Antique Oak has more variance between boards.

Material Calculator

The area (m²) is the total wall area to be clad.

m² = width x height

(minus the area of any windows & doors)

Number of boards = m² / 1.53

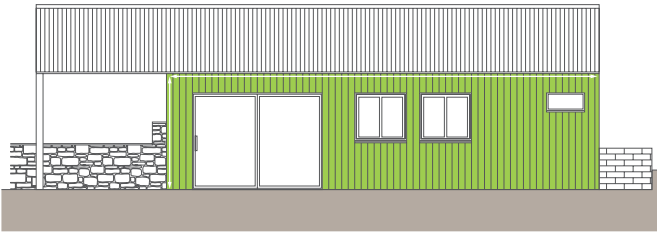

Vertical Installation

Vertical starter Trims = length of cladding area / 2.5

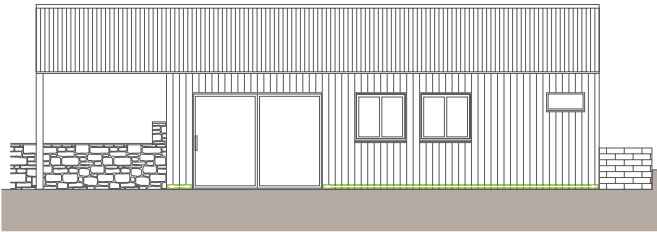

Perforated Closures will be needed at the top & bottom of the cladding and any windows, and the top of any doors.

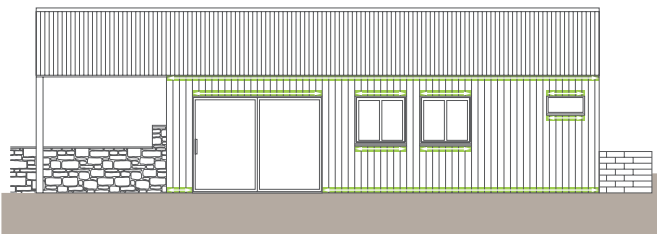

Number of perforated closures = [(width of cladding area x 2) + (width of all windows x 2) + (width of all doors)] / 3

Corners, windows & doors

External/Internal Corner Profiles = total linear m for corners / 3

Fascia boards = total linear m around windows and doors / 3.6

Extra perforated closures = Number of corner profiles



Fixings

Number of boxes

30mm fixings = number of cladding boards x 10 / 250

20mm fixings = number of perforated closures x 10 / 100

Durafix 35mm = (number of fascia boards x 26) + number of cladding boards / 100

Touch-up coating = Number of fascia boards / 50

Tip:

Allow extra material for wastage and offcuts. We would recommend adding at least 10% to the quantities as complex designs may require more material.

Materials

Cladding boards & accessories



Envello Shadow Line Cladding boards



Dimensions: 200x18x3600mm

Face: 181mm

Boards per m²: 1.53*

Colours: Smoked Oak - MCG360D
 Antique Oak - MCG360A
 Golden Oak - MCG360G
 Burnt Cedar - MCG360R

Fixings: 35mm Durafix fixings, 30mm fixings

Millboard Fascia Boards



Dimensions: 146 x 16 x 3600mm

Colour: Smoked Oak - MFN360D

Antique Oak - MFN360A

Golden Oak - MFN360G

Burnt Cedar - MFN360R

Fixings: 35mm Durafix fixing

Fascias may be required for window/door reveals or soffits.

* When installed

Cladding boards & accessories

External Corner Profile

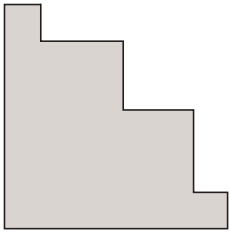

Dimensions: 50 x 50 x 3050mm
 Colours: Smoked Oak - MCPE50D
 Antique Oak - MCPE50A
 Golden Oak - MCPE50G
 Burnt Cedar - MCPE50R
 Fixings: Perforated closure, 20mm fixings

Profile used with the Shadow Line boards to finish off the external corner of the building.

Internal Corner Profile

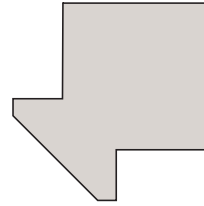

Dimensions: 38 x 38 x 3050mm
 Colours: Smoked Oak - MCPH38D
 Antique Oak - MCPH38A
 Golden Oak - MCPH38G
 Burnt Cedar - MCPH38R
 Fixings: Perforated closure, 20mm fixings

Profile used with the Shadow Line boards to finish off the internal corner of the building.

Horizontal Starter Trim J



Dimensions: 25 x 10 x 2500mm
 Product code: GT250J
 Fixings: 20mm fixings

Aluminium trim used to start the cladding at the bottom, when the cladding is installed horizontally.

Perforated Closure



Dimensions: 50 x 25 x 3000mm
 Product code: GP300L
 Fixings: 20mm fixings

Aluminium closure used to prevent insects/rodents getting into the ventilated cavity behind the boards, but allowing airflow. Fixed at the bottom of the cladding with the starter trim, also at the top on its own, as well as with the corner profile.

Materials

Cladding Accessories Fixings



Dimensions: 3.5 x 20mm
 Quantity: Box of 250
 Product code: FC20P250

A2 Stainless Steel fixings used to fix the corner trims, starter trims and perforated closures

Cladding Board Fixings



Dimensions: 3.5 x 30mm
 Quantity: Box of 250
 Product code: FC30P250

A2 Stainless Steel fixings used to fix the Envello cladding boards on to the battens, fixing through the tongue of the boards

Durafix Fixings



Dimensions: 4.5 x 35mm
 Quantity: Box of 100
 Product code: FT35P100

The Durafix A2 stainless steel fixings may be required for fixing the cladding boards where a fixing through the tongue isn't possible, also used for fixing fascia boards.

Step 1

No countersinking or pre-drilling required, drive the Durafix® straight in



Step 2

Sink so that the Durafix® head lies approximately 5mm below the surface



Step 3

The Lastane® surface is pliable, leaving a small witness mark

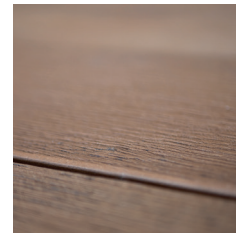

Tip for Durafix fixings:

When using the Durafix fixings, the fixings should firstly be coated in silicone spray.

When screwing in, push firmly on the screw whilst applying pressure to the board, finishing the screw head 5mm below the boards surface. This should leave a minimal witness mark.

Touch-up Coating



Smoked Oak
500ml AP500D



Antique Oak
500ml AP500A

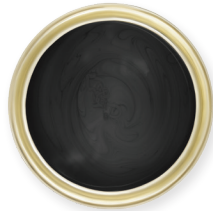

Burnt Cedar
500ml AP500R



Golden Oak
500ml AP500G

Touch-up used for coating any exposed cuts or edges on the Millboard Envello Cladding boards, corner trims or fascia boards.

Additional items that may be required (supplied by others):

- Flashing/drip profiles (around windows/doors/openings or at the bottom of the cladding)
- Fixings for installing the battens on to the structure (suitable type of fixing for the structure and battens used)
- Screws for fixing the battens together (suitable type of screw for the location and battens used)
- Clear low-modulus silicone sealant (to help prevent water penetrating through the system)
- Silicone spray (for when using the Durafix fixings)
- Polyurethane wood glue (used when mitring the boards)
- Super glue (used when mitring the boards)
- Suitable treated timber battens





Preparation

Ventilation

Ventilation for the control of moisture is a key element in the design and construction of cladding. It is a requirement not an option and should not be overlooked. A continuous airflow from bottom to top is vital for long term durability.

As a rainscreen system it assumes that the cladding will always be subject to some moisture penetration, therefore the surface that the battens will be fixed to needs to provide the waterproof finish.

Although a breather membrane is necessary for a timber frame, it may not be required on a masonry cavity wall.

Where the substrate is an existing building with solid walls (i.e. no cavity), to prevent water penetration the wall should be given a waterproof coating or better still a breathable membrane should be fitted.

Whatever system is used a minimum 19mm open cavity should always be provided behind the cladding and a minimum 10mm continuous gap left at the top and bottom of the system for full ventilation to dissipate any condensation or drainage at the bottom.

Consideration regarding insect and rodent invasion should also be considered and a perforated closure should be used to counter these threats where there is the required air gap, whilst still maintaining the required air flow.



Preparation

Cladding support batten

The time and care taken on setting/fixing the support system right will be reflected in the finished result. Time taken to upright corners and straighten battens on undulating walls will make the installation of the cladding a far easier installation and a superior finished result.

Suitable treated timber battens can be used as the battens for the cladding boards, we would recommend putting a strip of DPC, joist tape or EPDM on to the front of the timber battens that the boards will be attached to.

Batten size requirements:

- Main Cladding batten - minimum size of 25x50mm

The maximum support spacing is shown in table 1. For areas of high wind loading exceeding 1.0kN/m^2 , severe weather exposure or where exceptional impact loading requirements are anticipated (i.e. low-level applications near pedestrian access, schools, leisure facilities etc.) batten support spacing should be reduced to increase the board stiffness, see chart below.

There should always be battens attached to the wall vertically to allow clear ventilation behind the boards, with a vertical cladding installation a further set of horizontal cross-battens would be fixed to these vertical battens to take the boards

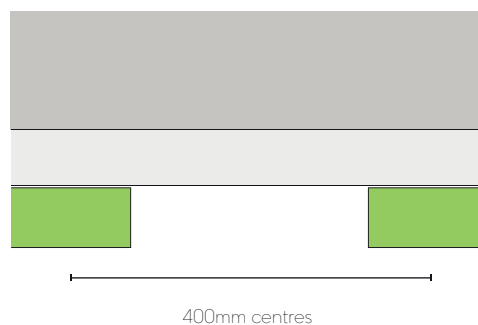

Table 1:

Product	Maximum Support Centres	Support Centres for high load areas
Shadow Line	400mm	300mm

The batten layout around windows/doors/soffits should be that it allows the continuous airflow behind the boards. a 10mm gap should be left between the underside of the windowsills or soffits and at the head of windows/doors). The battens up the side of the window/doors should be flush with the opening; all vertical battens should be upright.

The perforated closure should be used in all areas where there is an opening to the ventilated cavity, to prevent insects entering the cavity (The perforated closures may need to be turned up at each end of the window/door sill). The Millboard Perforated closure suits batten sizes of 25 or 50mm, if battens different to these sizes are used then perforated closures or flymesh supplied by others should be used.

It is best for the perforated closure to be held between the back of the battens and the wall. This should be taken in to consideration when fixing the battens, alternatively they can be fixed to the front of the battens using the 20mm Accessories fixings.

Determine at what height the cladding is to start at. If it is starting at ground level, it should start at a minimum of 150mm above finished ground level, or at least 10mm from decking/ free-draining surface. With a laser line or level, mark up a level line around the building or along the wall that is to be clad. This line will be the bottom of the batten/s.

Battens should be fixed to the structural wall using suitable external grade fixings, for fixing to a timber frame the battens should preferably be fixed into the timber studs of the frame. The battens should be fixed upright, packers may be needed for these if the wall is undulating.

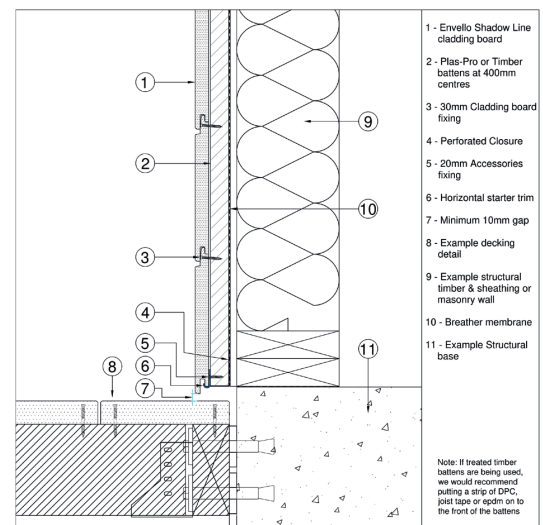
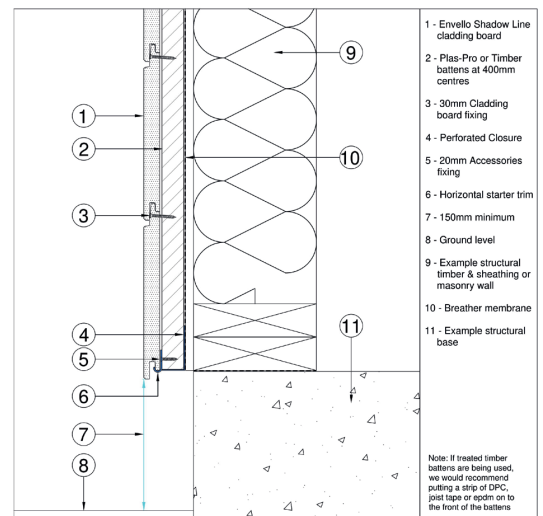
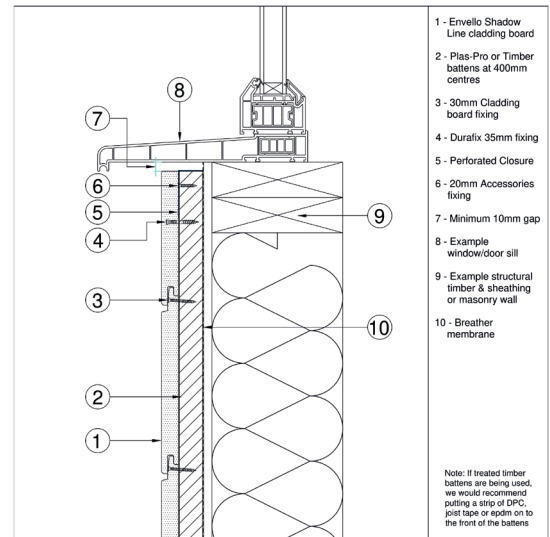

Installation

Before starting to install the main cladding area, it is important to take into consideration how the corners will be detailed (corners of the building and also corners of openings - windows/doors).

Corners of the building

When using the Shadow Line Board the External and Internal Corner Profiles can be used. These allow the boards to butt up to it and hide any potential shrinkage..

If the External Corner profile or Internal Corner profile are being used with the Shadow Line boards on the edges of the buildings, these should be fitted first before the starter trims

The perforated closure is fitted to the back of the External or Internal Corner profile using the 20mm Accessories Screw at 200mm centres, these are then fixed to the battens on the corner.

These are best to be fixed as shown, however they can be fixed with the Durafix fixing through the face but the fixing holes will be visible.

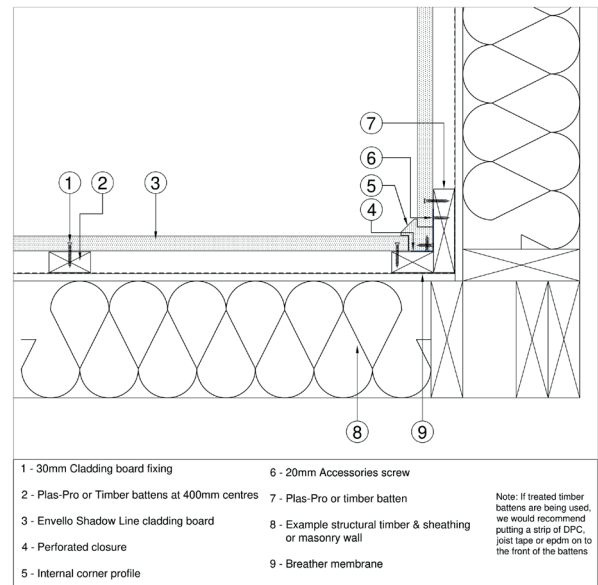
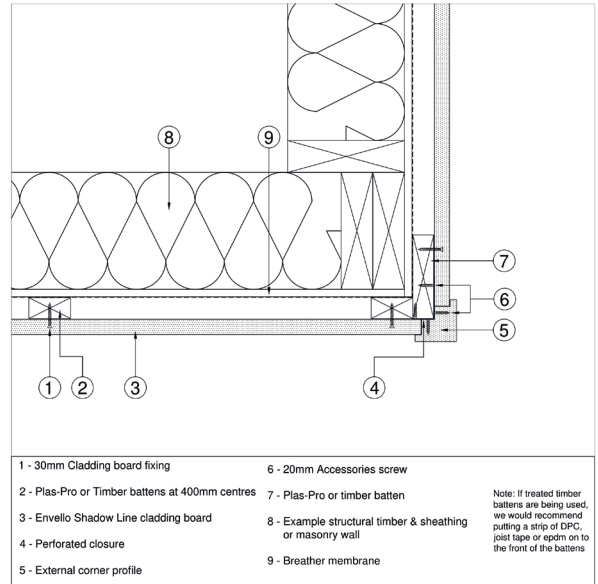
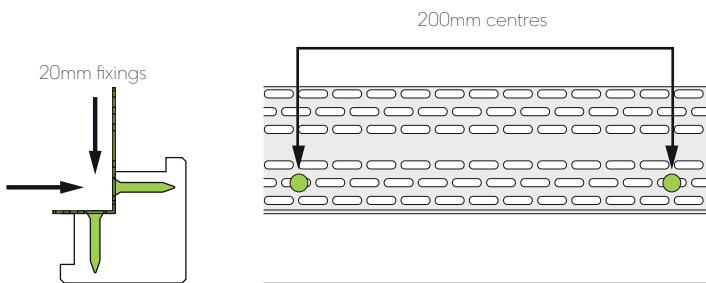

Alternatively, the boards can be mitred to create the external corner, this would also be applicable if the corner is anything other than 90 degrees.

When using the boards horizontally it is best to use the same board around the corner so that the wood grain, colour tone, and profile match.

Tip for mitre joints:

Mitre and dry fit the boards to make sure the joint fits well, apply polyurethane wood glue to the core of the boards and superglue to the lastane surface.

Bring the joint together with the lastane front edge touching together first, then close the back of the joint and drop into place. If any PU glue bubbles out of the joint, wait until it is semi-dry and remove. Touch-up Coating can be used on any small imperfections on this joint.

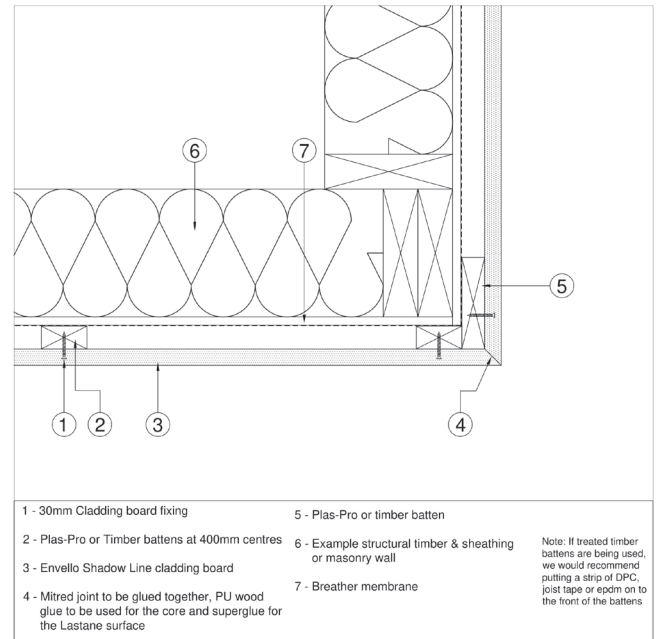

Joining Square Corner Trims

When joining two Corner Trims together to make a longer length, these should be joined on a 20 degree scarf joint. They should be joined so that the perforated closure connects both profiles together, dry fit the joint before cutting the profiles to length. The bottom cut should be painted in Touch-up Coating.

Details around windows & doors

Around windows and door openings we would recommend using the fascia boards to cover the reveals with the cladding boards butted up to the back of them. The fascia boards will need to be fixed with the Durafix fixings through the face.

The back edge of the fascia boards will need to be painted in Touch-up Coating if they will be visible, silicone sealant will be needed between the cladding boards and fascia boards and between the fascia boards and the window to reduce the risk of water penetrating behind.

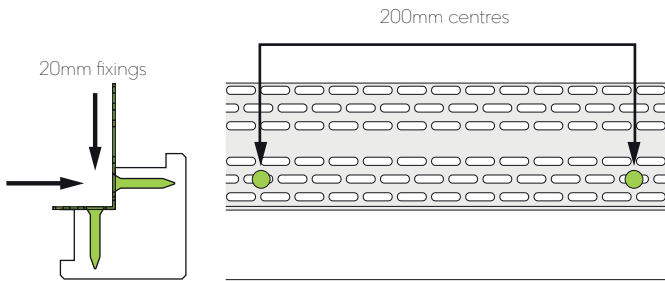
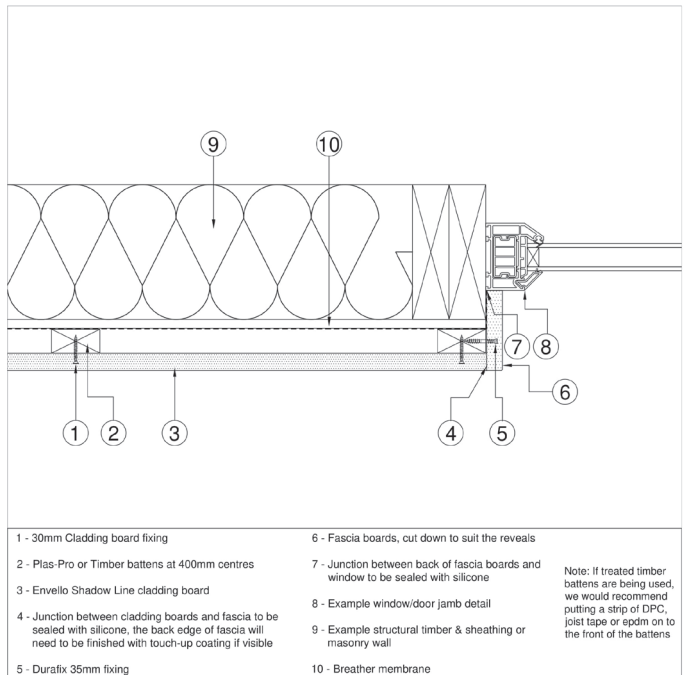
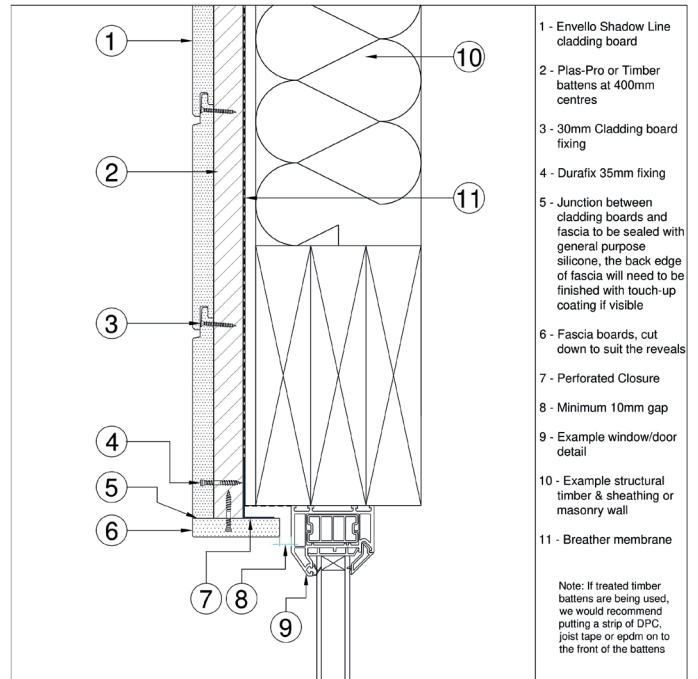

Fig. 11 - Use of perforated closure on external corner trims

Fascia boards are used to line the inside of the reveals, either fixed to the timber battens/framework or bonded to the masonry using MS polymer adhesive (please note the back of the fascia will need to be sanded before being bonded to masonry, to give the adhesive a key to hold the fascia).

Please ensure that all windows and doors are sealed sufficiently before installing cladding around them, ensure that the cladding detailing doesn't have a detrimental impact on the performance of the windows/door.



Use silicone behind the fascia boards where they meet the window to prevent the passage of any water getting through.

Alternatively the boards can be mitred and run back into the window reveal.

Care should be taken not to block the air gap at the top of the reveal and under the sill, leaving a clear 10mm gap.

Any detailing around an opening should allow for airflow to get in to the cavity above the opening.

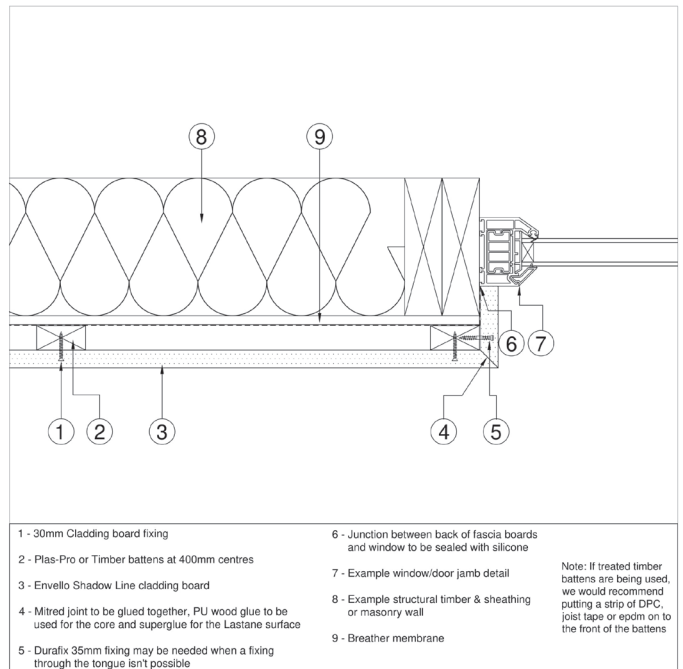
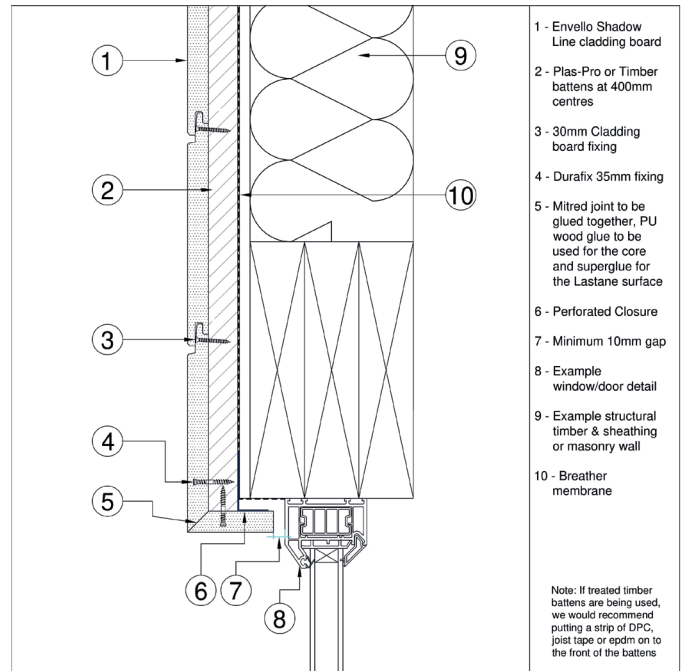

Installing Starter Trims

The Starter trims will be fitted to the bottom of the battens.

It is important that these trims are installed level so that the boards running off these trims are level.

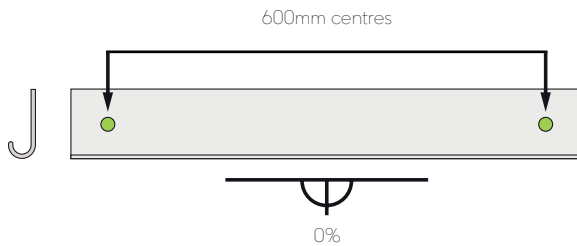

These starter trims are fixed to the battens using the 20mm Accessories screws with the heads countersunk into the trim.

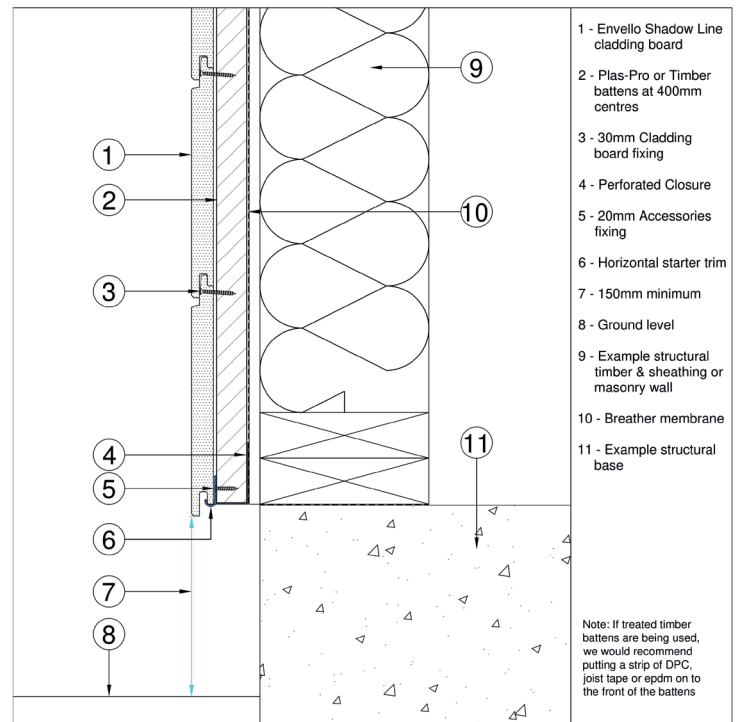

Fixings

The Millboard Envello Cladding boards should be fixed through the tongue with the 3.5x30mm cladding screws, with one fixing per batten intersection.

The fixings should be inserted through the fixing guide groove on the tongue and angled down slightly, the head should sit flush with the surface.

The fixings do not need to be predrilled or countersunk, the boards will allow the head to countersink slightly.

Once the first row of boards have been installed, the second row of boards can be installed beside it, with the groove covering the tongue of the previous board.

Check the boards against a level every 4/5th board to ensure that the boards are keeping upright, adjust the spacing between the following boards accordingly if needed.

Joining boards

When joining boards end-to-end, this should be done where there is a batten behind, so both ends are supported by a batten. It is best to not have the joins all in one line, so that they are spread out across the cladding area.

As the boards are manufactured through a moulding process we recommend that all ends are cut before they're installed. Dry fit the boards first to make sure they align, using boards that are of appropriate dimensions to ensure a consistent finish.

We recommend that the boards are joined with a 20 degree scarf joint with one overlapping the other, the front face of the cut should be painted in Touch-up Coating.

As Millboard is made from a resin mineral composition it is stable in comparison to timber or composites based on timber, the amount of movement that is acceptable is up to 0.2%.

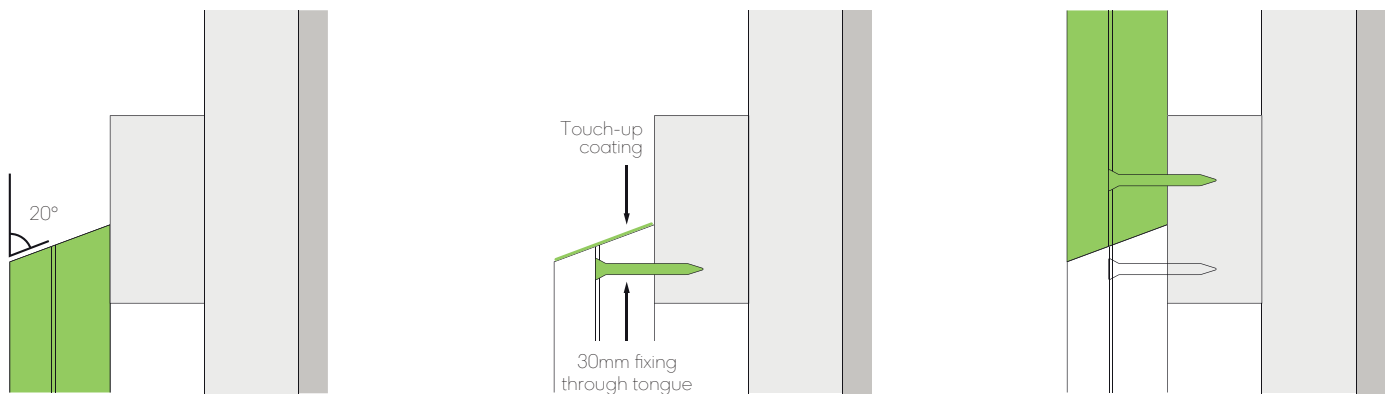

Fig. 18 - Joining boards detail

Installation Abutting Render

The junction between envello and render can be done in a number of different ways, however we'd recommend doing the rendering first before fitting the Envello and finishing the render up to a render stop bead rather than directly up to the cladding.

Please ensure that you leave a 3-4mm gap between the render stop and the edge of the cladding/corner trims.

When running the Shadow Line boards up to render on a wall, the boards can be butted up to the render stop-bead.

The junction between the Shadow Line boards and render on a corner can be done utilising the Envello Square Corner Trim.

When installing cladding above render, it is best to install a flashing detail which goes up behind the cladding battens and protrudes further than the render. This is to allow rain water to drip off the flashing detail.

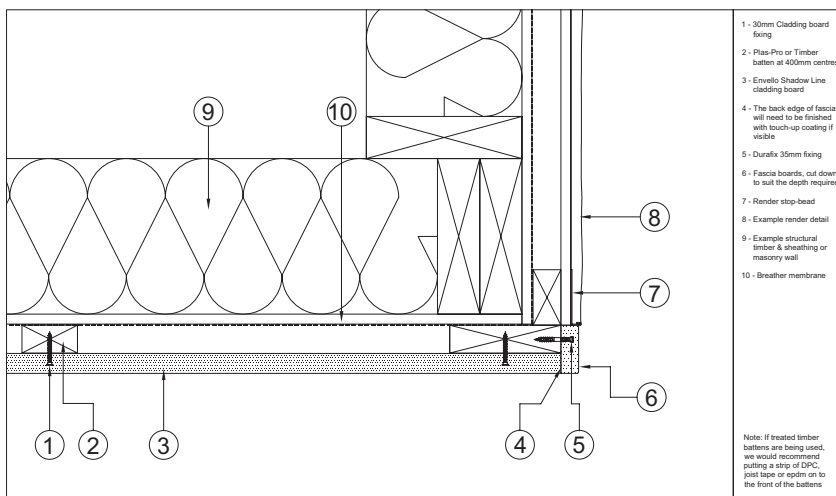
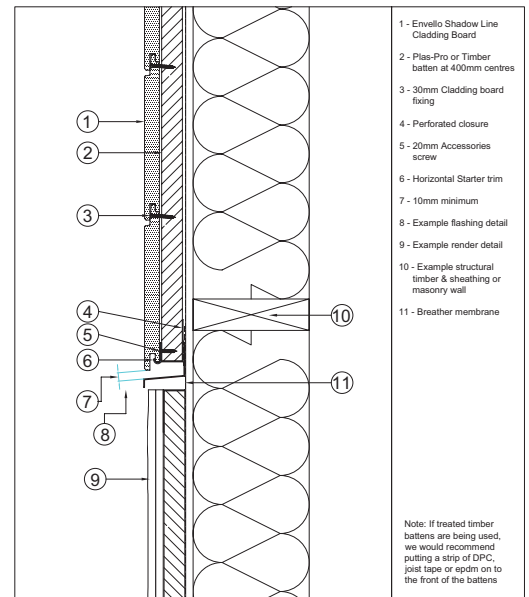
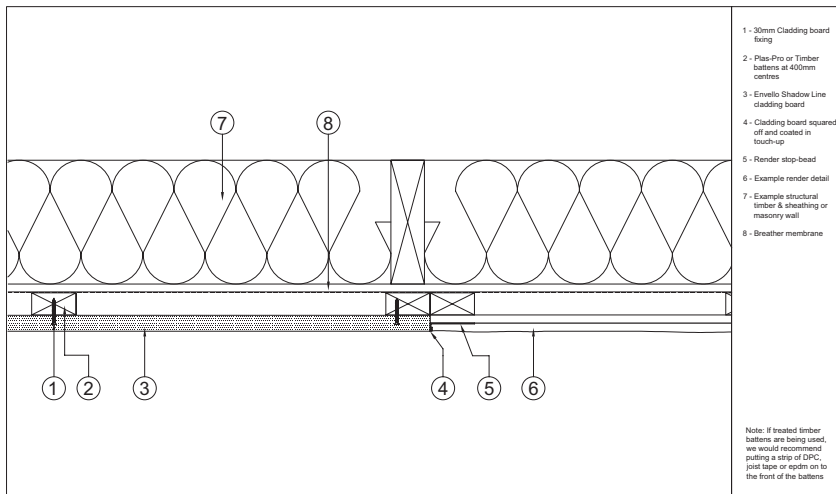

After care

Cleaning

If the boards become dirty during installation, they should be cleaned as soon as possible using warm soapy water and a brush or pressure washer.

Start cleaning at the top of the cladding and work downwards along the grain. It is best to use a brush with an extendable handle to clean the boards.

Pressure washers can be used on Millboard Envello Cladding, with a PSI of no greater than 2000. A fan tip should be used with a 40 to 60 degree spread, keeping the head 250-300mm away from the surface. Test in an inconspicuous area first - direct, prolonged contact could damage the surface of the boards.

Take extra care when using a pressure washer around windows, doors and cut ends of boards.

Stubborn marks may be removed with a range of different cleaners depending on the mark.

If you have any queries or concerns regarding your Millboard cladding, please email us at technical@millboard.co.uk, or call our UK support team on 024 7643 9943.

Live. Life. Outside.



The Millboard Company Ltd
UK Head Office
Unit A, Castle Court
Bodmin Road
Coventry CV2 5DB

T: +44 (0) 24 7643 9943
E: enquiries@millboard.co.uk

millboard.co.uk

Company registered No. 06061318
VAT No: 980 616602

© 2022 The Millboard Company Ltd., Millboard®, Lastane®, Durafix®, Lasta-Grip®, DuoSpan®, DuoLift®, Envello® and the phrase "Live. Life. Outside.™" are protected trademarks. Patents and Patents Pending apply to Millboard® products. The company will vigorously defend its patent rights. Due to printing restraints, actual colours may vary from those shown in brochure. This brochure is not to be reproduced or copied without written permission from Millboard directors. Millboard has a policy of continual improvement to specification. Product blend, colours and sizes may change without notice. All sizes and measurements are nominal. Information is correct at time of going to press. Patent numbers include GB 2445714, GB 2449184, USA 8,065,849, CAN 2664329, EU 1951971.